

BSI EXIT DEVICE

5810 SERIES GRADE 1 PUSH BAR



ANSI Accredited Program
PRODUCT CERTIFICATION

5810S Panic-Rated Rim Exit Device 5810F Fire-Rated Rim Exit Device



HEAD COVER OPTIONS



STRIKES

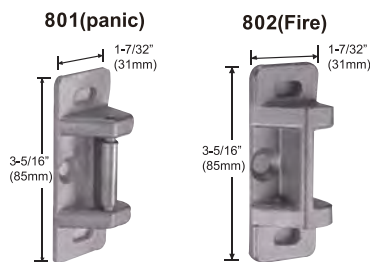

SPECIFICATIONS

- ★ **Device Lengths:** Short (36"): 33-15/32" (850mm), Long (48"): 44-3/4" (1137mm)
- ★ **Door Widths:** 36" - For 29" to 36" (736mm to 914mm) door size
48" - For 33" to 48" (838mm to 1219mm) door size
- ★ **Minimum Stile Width:** 4-1/4" (107mm)
- ★ **Latch Bolt:** 3/4" (19mm) throw, deadlocking design
- ★ **Strikes:** 801 (panic), 802 (fire)
- ★ **Dogging Kit:** Panic device - Hex key dogging (RD) standard
Fire device - No mechanical dogging (ND)
- ★ **Dogging Options:** Cylinder Dogging (CD), Less Dogging (LD)
- ★ **Mounting Fasteners:**
Panic device - Machine screws furnished standard
Fire device - Sex nuts and bolts (SNB) supplied standard
SNB are required to use for wood doors, order SNB separately
- ★ **Mounting Height:** Device centerline from finished floor is 40" (1016mm) standard
- ★ **Projection:** Push bar Neutral: 3-1/16" (78mm), Push bar Depressed: 2-19/32" (66mm)

APPLICATION

- ★ 5810S rim exit devices are used for all types of single and double doors with mullion.
- ★ 5810F rim exit devices are used for UL listed fire labeled single doors up to 4' x 8' (1219mm x 2438mm) or 8' x 8' (2438mm x 2438mm) double doors with mullion.
- ★ The exit devices are available in the following finishes: US3, US4, US10, US10B, US26, US26D and US32D.

Certification

- ★ **UL Listed:** UL listed as Panic Exit Hardware or 3-hour Fire Exit Hardware
- ★ **ANSI Certified:** Devices are ANSI A156.3 - 2008 Grade 1

5820 SERIES GRADE 1 PUSH BAR



- 5820F Fire-Rated Mortise Lock Exit Device
- 5820FSF Failsafe Electric Mortise Exit Device
- 5820FS Failsecure Electric Mortise Exit Device



HEAD COVER OPTIONS



STRIKES

818(panic)

828(fire)

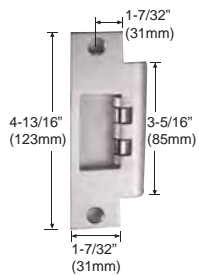

For use on 1-3/4" standard or 2-1/4" thick single door, and 2-1/4" double door with overlapping astragal and coordinator

SPECIFICATIONS

- ★ **Device Lengths:** Short (36"): 33-15/32" (850mm), Long (48"): 44-3/4" (1137mm)
- ★ **Door Widths:** 36" - For 29" to 36" (736mm to 914mm) door size
48" - For 33" to 48" (838mm to 1219mm) door size
- ★ **Minimum Stile Width:** 4-1/4" (107mm)
- ★ **Latch Bolt:** Stainless steel two-pieces mechanical 3/4" (19mm) with anti-friction insert and auxiliary deadlocking latch
- ★ **Strikes:** Universal curved lip, non-handed, 818(panic), 828(fire). Optional 831(panic) or 832 (fire) flat ANSI Strike for door pairs with overlapping astragal (7/8" lip)
- ★ **Dogging Kit:** Panic device - Hex key dogging (RD) standard
Fire device - No mechanical dogging (ND)
- ★ **Dogging Options:** Cylinder Dogging (CD), Less Dogging (LD)
- ★ **Mounting Fasteners:**
Panic device - Machine screws furnished standard
Fire device - Sex nuts and bolts (SNB) supplied standard
SNB are required to use for wood doors, order SNB separately
- ★ **Mounting Height:** Device centerline from finished floor is 40" (1016mm) standard
- ★ **Projection:** Push bar Neutral: 3-1/16" (78mm)
Push bar Depressed: 2-19/32" (66mm)

- ★ Field reversible failsecure/ failsafe, unlocks by access control, power loss or signal from fire command center. Door stays latched even when unlocked. Complies with national building and fire codes.
- ★ **Voltage:** 600/300 mA @ 12/24VDC
- ★ **Option:** L-Lock status output sensor

APPLICATION

- ★ 5820F mortise lock exit devices are used for UL listed fire labeled single doors up to 4' x 8' (1219mm x 2438mm) or (2438mm x 2438mm) double doors installations.

The exit devices are available in the following finishes: US3, US4, US10, US10B, US26, US26D and US32D.

5830 SERIES GRADE 1 PUSH BAR



5830S Panic-Rated SVR Exit Device
5830F Fire-Rated SVR Exit Device
5830F-1 Fire Rated SVR Exit Device



HEAD COVER OPTIONS



STRIKES

812(panic)

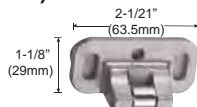

815(panic)



822(fire)

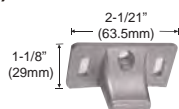

825(fire)



SPECIFICATIONS

- ★ **Device Lengths:** Short (36"): 33-15/32" (850mm),
Long (48"): 44-3/4" (1137mm)
- ★ **Door Widths:** 36" - For 29" to 36" (736mm to 914mm) door size
48" - For 38" to 48" (838mm to 1219mm) door size
- ★ **Minimum Stile Width:** 4-1/4" (107mm)
- ★ **Latch Bolt:**
Top latch - 5/8" (16mm) throw, can be deadlocked automatically
Bottom latch - 5/8" (16mm) throw, held retracted during door swing
- ★ **Strikes:** Top - 812 (panic), 822 (fire). Bottom - 815 (panic), 825 (fire)
- ★ **Dogging Kit:** Panic device - Hex key dogging (RD) standard
Fire device - No mechanical dogging (ND)
- ★ **Dogging Options:** Cylinder Dogging (CD), Less Dogging (LD)
- ★ **Mounting Fasteners:**
Panic device - Machine screws furnished for device standard
SND furnished for top & bottom latches
Fire device - Sex nuts and bolts (SNB) supplied standard
SNB are required to use for wood doors, order SNB separately
- ★ **Mounting Height:** Device centerline from finished floor is 40" (1016mm) standard
- ★ **Door opening Height:** Standard door height is 7', 8' is available
- ★ **Vertical Rods:** 1/2" (13mm) diameter tubular with rod guides
Top rod has two pieces to connect for accommodating 7' or 8' door
Bottom rod is one piece, its length is 31-1/4" (794mm)
- ★ **Projection:** Push bar Neutral: 3-1/16" (78mm)
Push bar Depressed: 2-19/32" (66mm)
- ★ **Distinguishing feature:**
Complies with NFPA 101 code for safety to life from buildings and structures
Include: surface vertical rod
Local visual status indicator
Alarm outputs
Door sign per code included
Bolt monitor

Certification

- ★ UL/cUL listed: FUKD/FUKD7- Controlled exit panic devices
- ★ ANSI certified: A156.3 Grade 1 & A156.24
- ★ BHMA listed: Directory of certified products

APPLICATION

- ★ Panic SVR exit devices are used for all types of single and double doors. Fire SVR exit devices are used for UL listed fire labeled pairs of doors up to 8' x 8' (2438mm x 2438mm)

5830 SERIES GRADE 1 PUSH BAR



Less Bottom Rod Exit Device
LBR5830S Panic-Rated SVR Exit Device
LBR5830F Fire-Rated SVR Exit Device



HEAD COVER OPTIONS



STRIKES

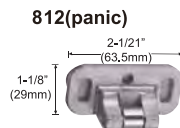

SPECIFICATIONS

- ★ **Device Lengths:** Short (36"): 33-15/32" (850mm), Long (48"): 44-3/4" (1137mm)
- ★ **Door Widths:** 36" - For 29" to 36" (736mm to 914mm) door size
48" - For 33" to 48" (838mm to 1219mm) door size
- ★ **Minimum Stile Width:** 4-1/4" (107mm)
- ★ **Latch Bolt:** Top latch - 5/8" (16mm) throw, can be deadlocked automatically
- ★ **Strikes:** Top - 812 (panic), 822 (fire), or 866 (panic or fire)
- ★ **Dogging Kit:** Panic device - Hex key dogging (RD) standard
Fire device - No mechanical dogging (ND)
- ★ **Dogging Options:** Cylinder Dogging (CD), Less Dogging (LD)
- ★ **Mounting Fasteners:** Panic device - Machine screws furnished for device standard SND furnished for top & bottom latches
Fire device - Sex nuts and bolts (SNB) supplied standard SNB are required to use for wood doors, order SNB separately
- ★ **Mounting Height:** Device centerline from finished floor is 40" (1016mm) standard
- ★ **Door opening Height:** Standard door height is 7', 8' is available
- ★ **Vertical Rods:** 1/2" (13mm) diameter tubular with rod guides
Top rod has two pieces to connect for accommodating 7' or 8' door
Projection: Push bar Neutral: 3-1/16" (78mm), Push bar Depressed: 2-19/32" (66mm)

APPLICATION

- ★ Panic LBR exit devices are used for all types of single and double doors. Fire LBR exit devices are used for UL listed fire labeled pairs of steel doors up to 8' x 8' (2438mm x 2438mm)
- ★ The exit devices are available in the following finishes: US3, US4, US10, US10B, US26, US26D and US32D.

5850 SERIES GRADE 1 PUSH BAR



Concealed Vertical Rod (CVR)
5850S Panic-Rated CVR Exit Device
5850F Fire-Rated CVR Exit Device



HEAD COVER OPTIONS

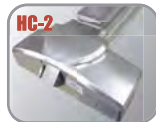

STRIKES

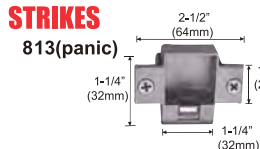

SPECIFICATIONS

- ★ **Device Lengths:** Short (36"): 33-15/32" (850mm), Long (48"): 44-3/4" (1137mm)
- ★ **Door Widths:** 36" - For 29" to 36" (736mm to 914mm) door size
48" - For 38" to 48" (838mm to 1219mm) door size
- ★ **Minimum Stile Width:** 4-1/4" (107mm)
- ★ **Latch Bolt:** Top latch - 5/8" (16mm) throw, can be deadlocked automatically
Bottom latch - 5/8" (16mm) throw, held retracted during door swing
- ★ **Strikes:** Top - 813 (panic), 823 (fire), Bottom - 815 (panic), 825 (fire)
- ★ **Dogging Kit:** Panic device - Hex key dogging (RD) standard
Fire device - No mechanical dogging (ND)
- ★ **Dogging Options:** Cylinder Dogging (CD), Less Dogging (LD)
- ★ **Mounting Fasteners:** Panic device - Machine screws furnished for device standard
Fire device - Sex nuts and bolts (SNB) supplied standard
- ★ **Mounting Height:** Device centerline from finished floor is 40" (1016mm) standard
- ★ **Door opening Height:** Standard door height is 7', 8' is available
- ★ **Vertical Rods:** 1/2" (13mm) diameter tubular
Top rod has two pieces to connect for accommodating 7' or 8' door
Bottom rod is one piece, its length is 31-1/4" (794mm)
- ★ **Projection:** Push bar Neutral: 3-1/16" (78mm), Push bar Depressed: 2-19/32" (66mm)

APPLICATION

- ★ Panic CVR exit devices are used on single or double metal doors. Fire CVR exit devices are used for UL listed fire labeled pairs of doors up to 8' x 8' (2438mm x 2438mm)
- ★ These CVR models cannot be omitted the bottom rod to use as Less Bottom Rod (LBR) devices.

5850 SERIES GRADE 1 PUSH BAR



**Wood Door Concealed Vertical Rod
WD5850S Panic-Rated CVR Exit Device
WD5850F Fire-Rated CVR Exit Device**



HEAD COVER OPTIONS



STRIKES

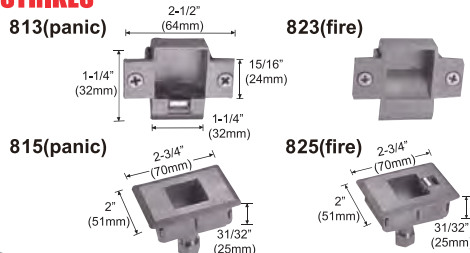

SPECIFICATIONS

- ★ **Device Lengths:** Short (36"): 33-15/32" (850mm), Long (48"): 44-3/4" (1137mm)
- ★ **Door Widths:** 36" - For 29" to 36" (736mm to 914mm) door size
48" - For 33" to 48" (838mm to 1219mm) door size
- ★ **Minimum Stile Width:** 4-1/4" (107mm)
- ★ **Latch Bolt:**
Top latch - 5/8" (16mm) throw, can be deadlocked automatically
Bottom latch - 5/8" (16mm) throw, held retracted during door swing
- ★ **Strikes:** Top - 813 (panic), 823 (fire). Bottom - 815 (panic), 825 (fire)
- ★ **Dogging Kit:** Panic device - Hex key dogging (RD) standard
Fire device - No mechanical dogging (ND)
- ★ **Dogging Options:** Cylinder Dogging (CD), Less Dogging (LD)
- ★ **Mounting Fasteners:** Sex nuts and bolts (SNB) supplied standard, devices for wood doors use are requested to mount by SNB
- ★ **Mounting Height:**
Device centerline from finished floor is 40" (1016mm) standard
- ★ **Door opening Height:** Standard door height is 7', 8' is available
- ★ **Vertical Rods:** 1/2" (13mm) diameter tubular
Top rod has two pieces to connect for accommodating 7' or 8' door
Bottom rod is one piece, length is 31-3/4"(794mm)
- ★ **Projection:** Push bar Neutral: 3-1/16" (78mm),
Push bar Depressed: 2-19/32" (66mm)

APPLICATION

- ★ Panic exit devices are used on single or double wood doors. Fire CVR exit devices are used for UL listed fire labeled pairs of wood doors up to 8' x 8' (2438mm x 2438mm)
- ★ These devices are furnished with two reinforced plated to strengthen both top edge and bottom edge of the wood door.

5710 SERIES GRADE 1 PUSH BAR



**5710S Narrow Design Panic-Rated Rim
Exit Device
5710F Narrow Design Fire-Rated Rim
Exit Device**



STRIKES

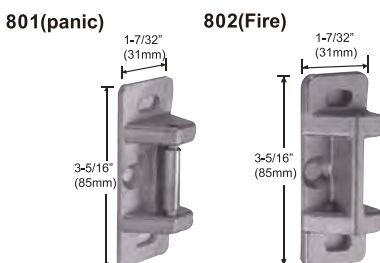

SPECIFICATIONS

- ★ **Device Lengths:** Short (36"): 33-15/32" (850mm), Long (48"): 44-3/4" (1137mm)
- ★ **Door Widths:** 36" - For 29" to 36" (736mm to 914mm) door size
48" - For 38" to 48" (838mm to 1219mm) door size
- ★ **Minimum Stile Width:** 2-19/32" (66mm)
- ★ **Latch Bolt:** 3/4" (19mm) throw, deadlocking design
- ★ **Strikes:** 801 (panic), 802 (fire)
- ★ **Dogging Kit:** Panic device - Hex key dogging (RD) standard
Fire device - No mechanical dogging (ND)
- ★ **Dogging Options:** Cylinder Dogging (CD), Less Dogging (LD)
- ★ **Mounting Fasteners:**
Panic device - Machine screws furnished standard
Optional SNB are available for device, order SNB separately
Fire device - Sex nuts and bolts (SNB) supplied standard
- ★ **Mounting Height:** Device centerline from finished floor is 40" (1016mm) standard
- ★ **Projection:** Push bar Neutral: 3-1/16" (78mm),
Push bar Depressed: 2-19/32" (66mm)

APPLICATION

- ★ 5710S narrow design rim exit devices are used for the aluminum frame full glass doors or narrow stile aluminum doors or narrow stile aluminum doors applications. 5710F narrow design rim exit devices are used for the aesthetics requirement of wide stile single doors up to 4' x 8' (1219mm x 2438mm) or 8' x 8' (2438mm x 2438mm) double metal or wood doors with mullion.
- ★ The exit devices are available in the following finishes: US3, US4, US10, US10B, US26, US26D and US32D.

5730 SERIES GRADE 1 PUSH BAR



5730S Narrow Design Panic-Rated SVR Exit Device
5730F Narrow Design Fire-Rated SVR Exit Device



STRIKES

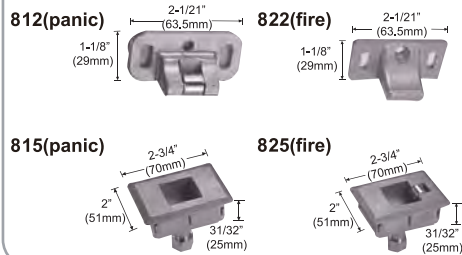

SPECIFICATIONS

- ★ **Device Lengths:** Short (36"): 33-15/32" (850mm), Long (48"): 44-3/4" (1137mm)
- ★ **Door Widths:** 36" - For 29" to 36" (736mm to 914mm) door size
48" - For 33" to 48" (838mm to 1219mm) door size
- ★ **Minimum Stile Width:** 2-19/32" (66mm)
- ★ **Latch Bolt:**
Top latch - 5/8" (16mm) throw, can be deadlocked automatically
Bottom latch - 5/8" (16mm) throw, held retracted during door swing
- ★ **Strikes:** Top - 812 (panic), 822 (fire). Bottom - 815 (panic), 825 (fire)
- ★ **Dogging Kit:** Panic device - Hex key dogging (RD) standard
Fire device - No mechanical dogging (ND)
- ★ **Dogging Options:** Cylinder Dogging (CD), Less Dogging (LD)
- ★ **Mounting Fasteners:** Sex nuts and bolts (SNB) supplied standard, SNB furnished for top & bottom latches
Option SNB are available for device
- ★ **Mounting Height:**
Device centerline from finished floor is 40" (1016mm) standard
- ★ **Door opening Height:** Standard door height is 7', 8' is available
- ★ **Vertical Rods:** 1/2" (13mm) diameter tubular with rod guides
Top rod has two pieces to connect for accommodating 7' or 8' door
Bottom rod is one piece, its length is 31-3/4(794mm)
- ★ **Projection:** Push bar Neutral: 3-1/16" (78mm),
Push bar Depressed: 2-19/32" (66mm)

APPLICATION

- ★ Narrow design Panic SVR exit devices are used for the aluminum frame full glass doors or narrow stile aluminum doors application.
- ★ Narrow design Fire SVR exit devices are used for the aesthetics requirements of wide stile pairs of metal or wood doors up to 8' x 8' (2438mm x 2438mm)

5750 SERIES GRADE 1 PUSH BAR



5750S Narrow Design Panic-Rated CVR Exit Device
5750F Narrow Design Fire-Rated CVR Exit Device



STRIKES

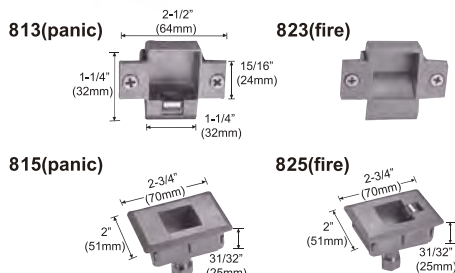

SPECIFICATIONS

- ★ **Device Lengths:** Short (36"): 33-15/32" (850mm), Long (48"): 44-3/4" (1137mm)
- ★ **Door Widths:** 36" - For 29" to 36" (736mm to 914mm) door size
48" - For 38" to 48" (838mm to 1219mm) door size
- ★ **Minimum Stile Width:** 2-19/32" (66mm)
- ★ **Latch Bolt:**
Top latch - 5/8" (16mm) throw, can be deadlocked automatically
Bottom latch - 5/8" (16mm) throw, held retracted during door swing
- ★ **Strikes:** Top - 813 (panic), 823 (fire). Bottom - 815 (panic), 825 (fire)
- ★ **Dogging Kit:** Panic device - Hex key dogging (RD) standard
Fire device - No mechanical dogging (ND)
- ★ **Dogging Options:** Cylinder Dogging (CD), Less Dogging (LD)
- ★ **Mounting Fasteners:**
Panic device - Machine screws furnished standard.
Optional SNB are available for device, order SNB separately
Fire device - Sex nuts and bolts (SNB) supplied standard
- ★ **Mounting Height:** Device centerline from finished floor is 40" (1016mm) standard
- ★ **Door Opening Height:** Standard door height is 7', 8' is available
- ★ **Vertical Rods:** 1/2" (13mm) diameter tubular
Top rod has two pieces to connect for accommodating 7' or 8' door
Bottom rod is one piece, its length is 31-1/4 (794mm)
- ★ **Projection:** Push bar Neutral: 3-1/16" (78mm),
Push bar Depressed: 2-19/32" (66mm)

APPLICATION

- ★ Narrow design Panic CVR exit devices are used for the aluminum frame full glass doors or narrow stile aluminum doors applications.
- ★ Narrow design Fire CVR exit devices are used for the aesthetics requirement of wide stile pairs of steel doors up to 8' x 8' (2438mm x 2438mm)

5610 SERIES GRADE 2 PUSH BAR



**5610S Panic-Rated Rim Exit Device
5610F Fire-Rated Rim Exit Device**



STRIKES

531 Strike Shim

Furnished with 532 Strike. This shim is 1/8" thick for prepare door with 1/2" stop. When the stop is 1/2" high, it is used to obtaining correct distance between the device latch and the surface applied strike . If the frame has 5/8" stop, then this shim is unnecessary.



532 Panic Rim Strike

Surface applied. Standard on 5500, 5600 Series panic rim exit devices. Stainless Steel, with a plated roller.



533 Fire Rim Strike

Surface applied. Standard on 5500, 5600 Series fire rim exit devices. Stainless Steel, with a plated roller.



SPECIFICATIONS

- ★ **Device Head Cover:** Stainless steel, nonferrous alloy
- ★ **Chassis:** Steel, plated
- ★ **Mechanism Housing:** Steel, stainless steel
- ★ **Push Bar:** Steel, stainless steel
- ★ **End Cap:** Steel, stainless steel
- ★ **Latch Bolt:** 100% stainless steel, deadlocking type, 11/16" (17mm) throw
- ★ **Deadlocking Latch:** 100% stainless steel 5/8" (16mm) throw
- ★ **Strike:** 531 & 532 Rim type (panic rated) 533 Rim (fire rated)
- ★ **Handing:** Non-handed
- ★ **Mounting Fasteners:** Machine screws furnished standard, Sex Nut and Bolt (SNB) are required to use for wood doors. Order SNB separately.
- ★ **Dogging:** Hex key dogging standard (Allen-type key furnished)
- ★ **Dogging Option:** Cylinder dogging (CD) or Less dogging (LD)
- ★ **Finish:** 605, 630, 680, 690 finishes
- ★ **Dimension:** Short: 20-15/32" (520mm), Long: 24-31/32"(640mm)
- ★ **Device Length:** Short: 33-15/32"(850mm), Long: 44-3/4"(1137mm)
- ★ **Projection:** Neutral: 2-7/16" (520mm), Depressed: 1-11/16"(43mm)

APPLICATION

- ★ For use on single doors or double doors with mullion (Fire rated device must use on 4' x 8' single or 8' x 8' double fire labeled doors).
- ★ Fits for 1-3/4" (44mm) thick standard RHR or LHR hollow metal doors & wood doors, other than standard 1-3/4" is available but specify door thickness when ordered.
- ★ Minimum Stile Width: 3-1/2" (90mm)

5630 SERIES GRADE 2 PUSH BAR



**5630S Panic-Rated SVR Exit Device
5630F Fire-Rated SVR Exit Device**



STRIKES

534 Top Strike

Applied to surface of stop. Hardened steel plated.



537 Bottom Strike

Applied to surface of floor. Nonferrous alloy plated.



SPECIFICATIONS

- ★ **Device Head Cover:** Stainless steel, nonferrous alloy
- ★ **Chassis:** Steel, plated
- ★ **Mechanism Housing:** Steel, stainless steel
- ★ **Push Bar:** Steel, stainless steel
- ★ **End Cap:** Steel, stainless steel
- ★ **Latch Bolt:** 100% stainless steel, deadlocking type, 1/2" (13mm) throw
- ★ **Latch Case Covers:** Steel, stainless steel
- ★ **Vertical Rods:** Tubular aluminum with rod guides
- ★ **Strike:** Top 534, Bottom 537
- ★ **Handing:** Non-handed
- ★ **Mounting Fasteners:** Machine screws furnished standard, Sex Nut and Bolt (SNB) are required to use for wood doors. Order SNB separately.
- ★ **Dogging:** Hex key dogging standard (Allen-type key furnished)
- ★ **Dogging Option:** Cylinder dogging (CD) or Less dogging (LD)
- ★ **Finish:** 605, 630, 680, 690 finishes
- ★ **Dimension:** Short: 20-15/32" (520mm), Long: 24-31/32"(850mm)
- ★ **Device Length:** Short: 33-15/32"(850mm), Long: 44-3/4"(1137mm)
- ★ **Projection:** Neutral: 2-7/16" (520mm), Depressed: 1-11/16"(43mm)

APPLICATION

- ★ For use on all single doors or double doors where two-point latch is desirable (inactive leaf of double door in specialty). (Fire rated device must use on 4' x 8' single or 8' x 8' double fire labeled doors).
- ★ Fits for 1-3/4" (44mm) thick standard RHR and LRH hollow metal doors, other than standard 1-3/4" is available but specify door thickness when ordered.
- ★ Minimum Door Stile Width: 3-1/2" (90mm)

5510 SERIES GRADE 2 PUSH BAR



5510S Panic-Rated Exit Device 5510F Fire-Rated Exit Device



STRIKES



531 Strike Shim

Furnished with 532 Strike. This shim is 1/8" thick for prepare door with 1/2" stop. When the stop is 1/2" high, it is used to obtaining correct distance between the device latch and the surface applied strike. If the frame has 5/8" stop, then this shim is unnecessary.



532 Panic Rim Strike

Surface applied. Standard on 5500, 5600 Series panic rim exit devices. Stainless Steel, with a plated roller.

SPECIFICATIONS

- ★ **Device Head Cover:** Stainless steel, nonferrous alloy
- ★ **Chassis:** Steel, plated
- ★ **Mechanism Housing:** Steel, stainless steel
- ★ **Push Bar:** Steel, stainless steel
- ★ **End Cap:** Steel, stainless steel
- ★ **Latch Bolt:**
100% stainless steel, deadlocking type, 11/16" (17mm) throw
- ★ **Deadlocking Latch:** 100% stainless steel 5/8" (16mm) throw
- ★ **Strike:** 531 & 532 Rim type
- ★ **Handing:** Non-handed
- ★ **Mounting Fasteners:** Machine screws furnished standard, Sex Nut and Bolt (SNB) are required to use for wood doors. Order SNB separately.
- ★ **Dogging:** Hex key dogging standard (Allen-type key furnished)
- ★ **Dogging Option:** Cylinder dogging (CD) or Less dogging (LD)
- ★ **Finish:** 605, 630, 680, 690 finishes
- ★ **Dimension:** Short: 20-15/32" (520mm), Long: 24-31/32" (640mm)
- ★ **Device Length:** Short: 33-15/32" (850mm), Long: 44-3/4" (1137mm)
- ★ **Projection:** Neutral: 2-7/16" (520mm), Depressed: 1-11/16" (43mm)

APPLICATION

- ★ For use on single doors or double doors with mullion (Fire rated device must use on 4' x 8' single or 8' x 8' double fire labeled doors).
- ★ Fits for 1-3/4" (44mm) thick standard RHR or LHR hollow metal doors & wood doors, other than standard 1-3/4" is available but specify door thickness when ordered.
- ★ Minimum Stile Width: 2-1/2" (63mm)

5530 SERIES GRADE 2 PUSH BAR



5530S Panic-Rated SVR Exit Device 5530F Fire-Rated SVR Exit Device



STRIKES



534 Top Strike

Applied to surface of stop. Hardened steel plated.



537 Bottom Strike

Applied to surface of floor. Nonferrous alloy plated.

SPECIFICATIONS

- ★ **Device Head Cover:** Stainless steel, nonferrous alloy
- ★ **Chassis:** Steel, plated
- ★ **Mechanism Housing:** Steel, stainless steel
- ★ **Push Bar:** Steel, stainless steel
- ★ **End Cap:** Steel, stainless steel
- ★ **Latch Bolt:**
100% stainless steel, deadlocking type, 1/2" (13mm) throw
- ★ **Latch Case Covers:** Steel, stainless steel
- ★ **Vertical Rods:** Tubular aluminum with rod guides
- ★ **Strike:** Top 534, Bottom 537
- ★ **Handing:** Non-handed
- ★ **Mounting Fasteners:** Machine screws furnished standard, Sex Nut and Bolt (SNB) are required to use for wood doors. Order SNB separately.
- ★ **Dogging:** Hex key dogging standard (Allen-type key furnished)
- ★ **Dogging Option:** Cylinder dogging (CD) or Less dogging (LD)
- ★ **Finish:** 605, 630, 680, 690 finishes
- ★ **Dimension:** Short: 20-15/32" (520mm), Long: 24-31/32" (850mm)
- ★ **Device Length:** Short: 33-15/32" (850mm), Long: 44-3/4" (1137mm)
- ★ **Projection:** Neutral: 2-7/16" (520mm), Depressed: 1-11/16" (43mm)

APPLICATION

- ★ For use on all single doors or double doors where two-point latch is desirable (inactive leaf of double door in specialty). (Fire rated device must use on 4' x 8' single or 8' x 8' double fire labeled doors).
- ★ Fits for 1-3/4" (44mm) thick standard RHR and LRH hollow metal doors, other than standard 1-3/4" is available but specify door thickness when ordered.
- ★ Minimum Door Stile Width: 2-1/2" (63mm)

Alarmed Exit Devices

An emergency exit device of the push bar type to control entry and exit of personnel, including a crossbar which may be pushed toward a door to actuate mechanisms which retract a latch bolt, and an alarm and key system for selective alarm actuation. The alarm and key system includes internal control mechanisms which are mounted in a tamper-proof housing, which may be accessed only by operating the push bar and actuating the alarm.

Application

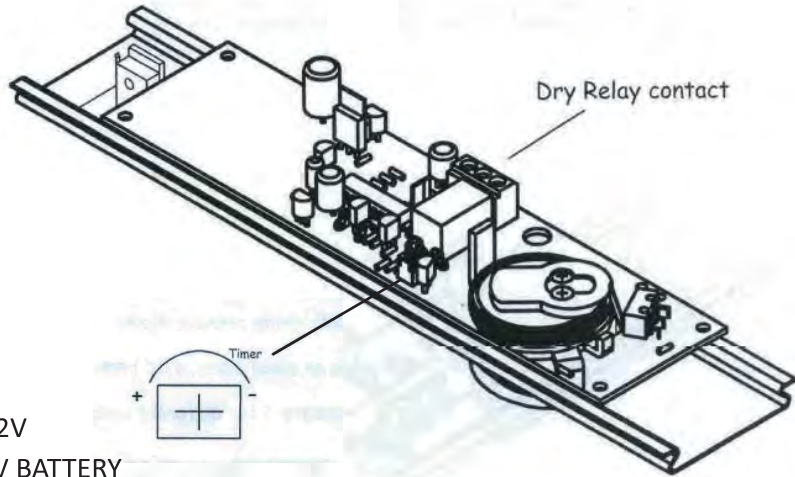

Model

- EAK500A FOR GRADE 1 INPUT VOLTAGE: 12V
- EAK500A-1 FOR GRADE 1 INPUT VOLTAGE: 9V BATTERY
- EAK500B FOR GRADE 2 INPUT VOLTAGE: 12V
- EAK500B-1 FOR GRADE 2 INPUT VOLTAGE: 9V BATTERY

Wiring Diagrams

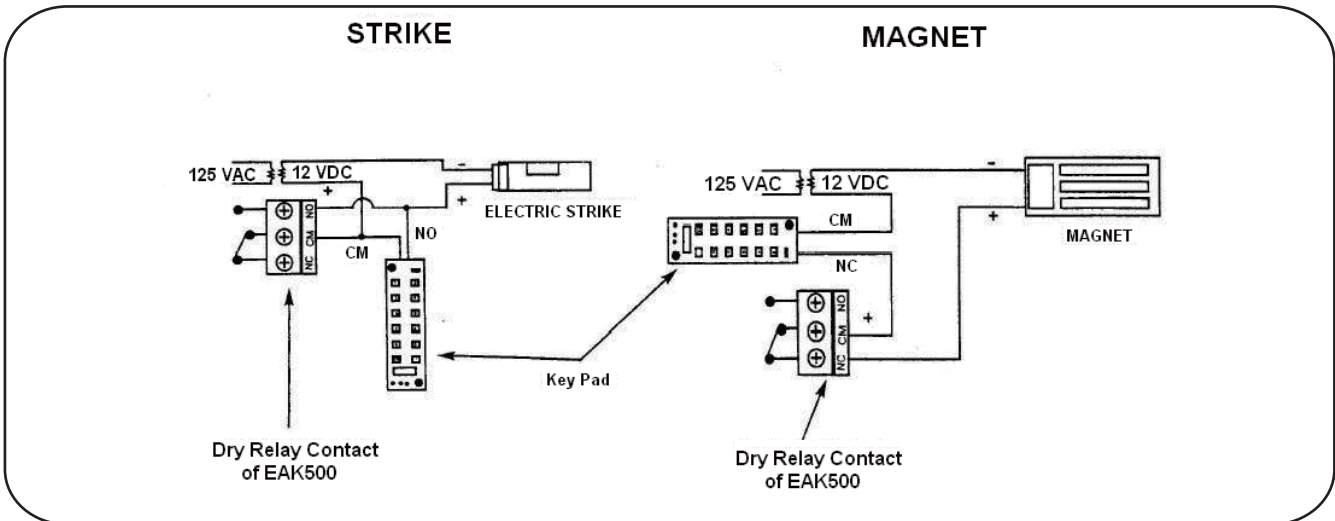

APPLICATION

SINGLE DOOR



One Rim Device is the popular choice for use on single outwardly swing door use. In this application any device may be used.

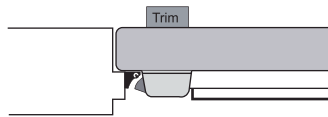

DOUBLE DOOR WITH MULLION



Two rim Devices with mullion - same direction

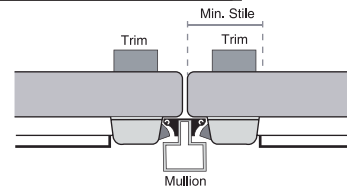

DOUBLE DOOR



Rim Device (or Mortise Lock Device) and Surface Vertical Rod Device combination - Same direction

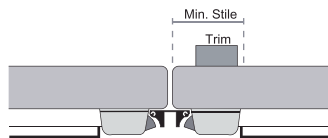

DOUBLE DOOR



Two Surface Vertical Rod (SVR) or Concealed Vertical Rod (CVR) - same direction. Overlapping astragal is not required.

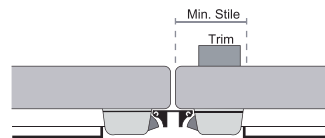

DOUBLE DOOR REVERSE OPENING

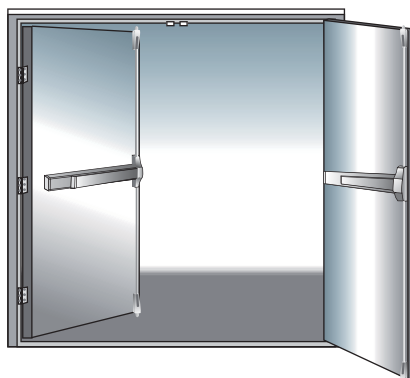

Two Surface Vertical Rod (SVR) or Concealed Vertical Rod (CVR) Devices - double egress. Overlapping astragal required or not required, option.

DOOR HANDING

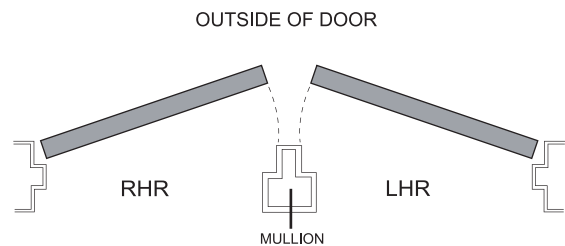

Use this diagram to determine the hand of door.

GRADE 1 PUSH BAR DIMENSIONS

Wide Stile Exit Device

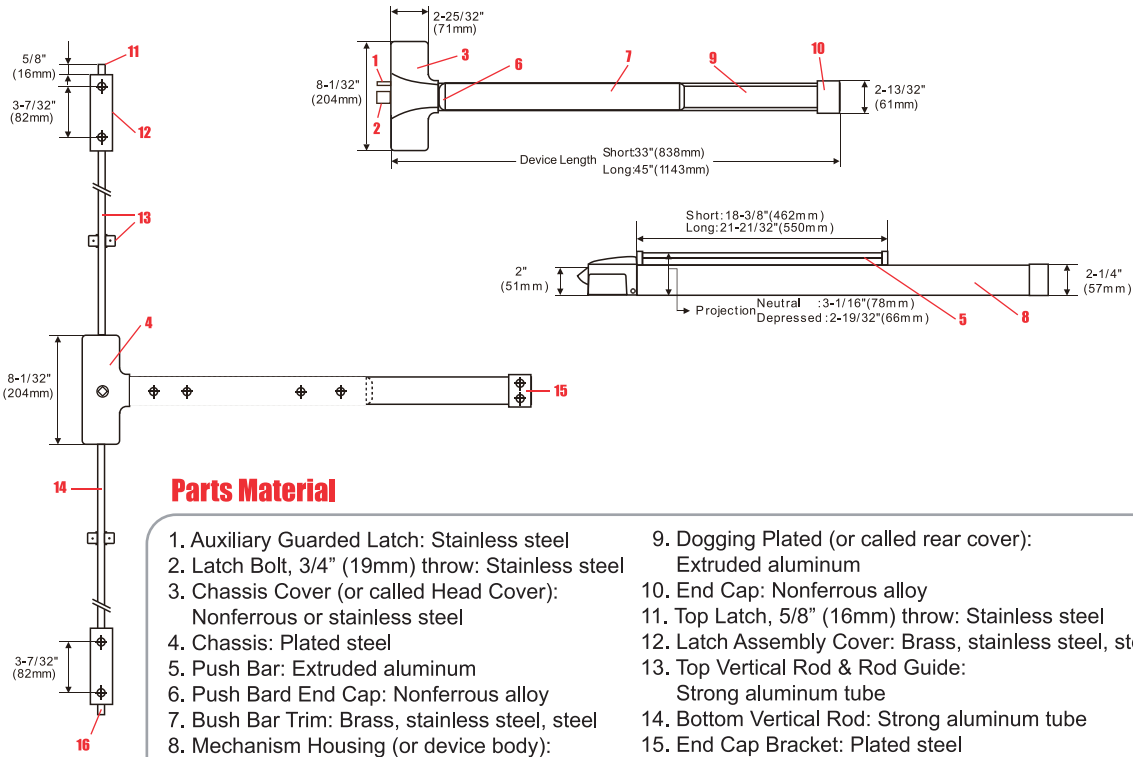

Parts Material

- | | |
|--|---|
| 1. Auxiliary Guarded Latch: Stainless steel | 9. Dogging Plated (or called rear cover): Extruded aluminum |
| 2. Latch Bolt, 3/4" (19mm) throw: Stainless steel | 10. End Cap: Nonferrous alloy |
| 3. Chassis Cover (or called Head Cover): Nonferrous or stainless steel | 11. Top Latch, 5/8" (16mm) throw: Stainless steel |
| 4. Chassis: Plated steel | 12. Latch Assembly Cover: Brass, stainless steel, steel |
| 5. Push Bar: Extruded aluminum | 13. Top Vertical Rod & Rod Guide: Strong aluminum tube |
| 6. Push Bar End Cap: Nonferrous alloy | 14. Bottom Vertical Rod: Strong aluminum tube |
| 7. Bush Bar Trim: Brass, stainless steel, steel | 15. End Cap Bracket: Plated steel |
| 8. Mechanism Housing (or device body): Extruded aluminum | 16. Bottom Latch, 5/8" (16mm) throw: Stainless steel |

Narrow Stile Exit Device

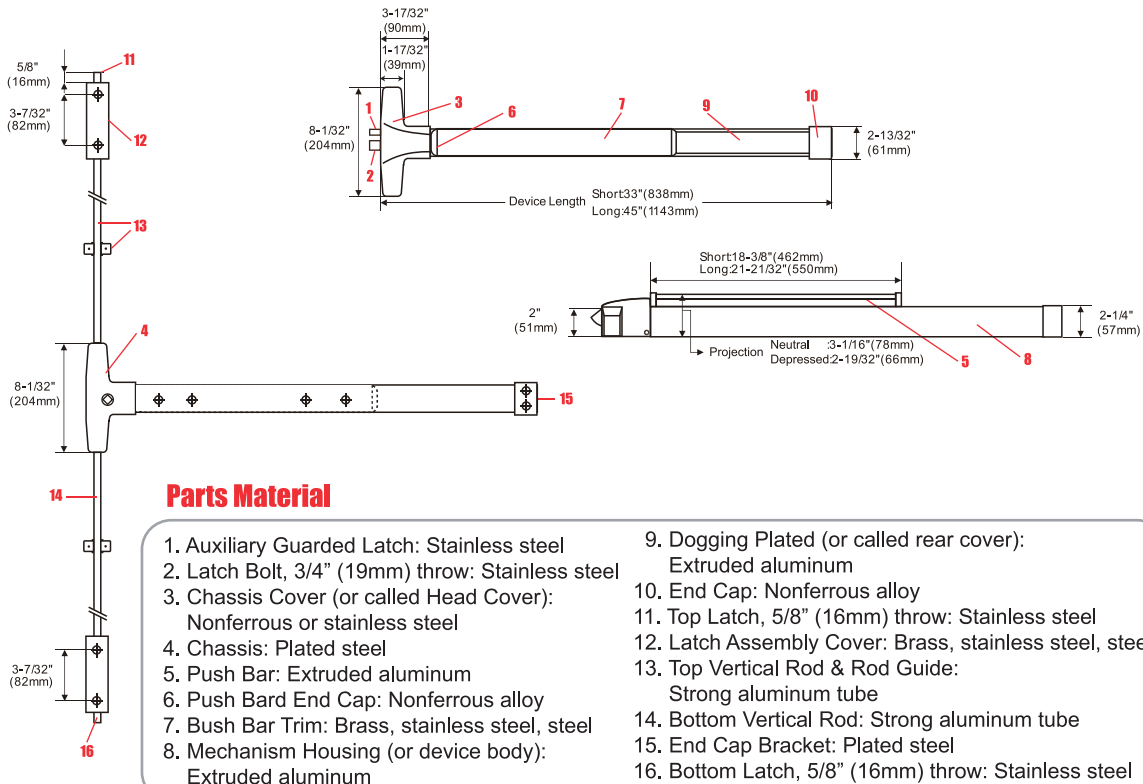

Parts Material

- | | |
|--|---|
| 1. Auxiliary Guarded Latch: Stainless steel | 9. Dogging Plated (or called rear cover): Extruded aluminum |
| 2. Latch Bolt, 3/4" (19mm) throw: Stainless steel | 10. End Cap: Nonferrous alloy |
| 3. Chassis Cover (or called Head Cover): Nonferrous or stainless steel | 11. Top Latch, 5/8" (16mm) throw: Stainless steel |
| 4. Chassis: Plated steel | 12. Latch Assembly Cover: Brass, stainless steel, steel |
| 5. Push Bar: Extruded aluminum | 13. Top Vertical Rod & Rod Guide: Strong aluminum tube |
| 6. Push Bar End Cap: Nonferrous alloy | 14. Bottom Vertical Rod: Strong aluminum tube |
| 7. Bush Bar Trim: Brass, stainless steel, steel | 15. End Cap Bracket: Plated steel |
| 8. Mechanism Housing (or device body): Extruded aluminum | 16. Bottom Latch, 5/8" (16mm) throw: Stainless steel |

GRADE 2 PUSH BAR DIMENSIONS

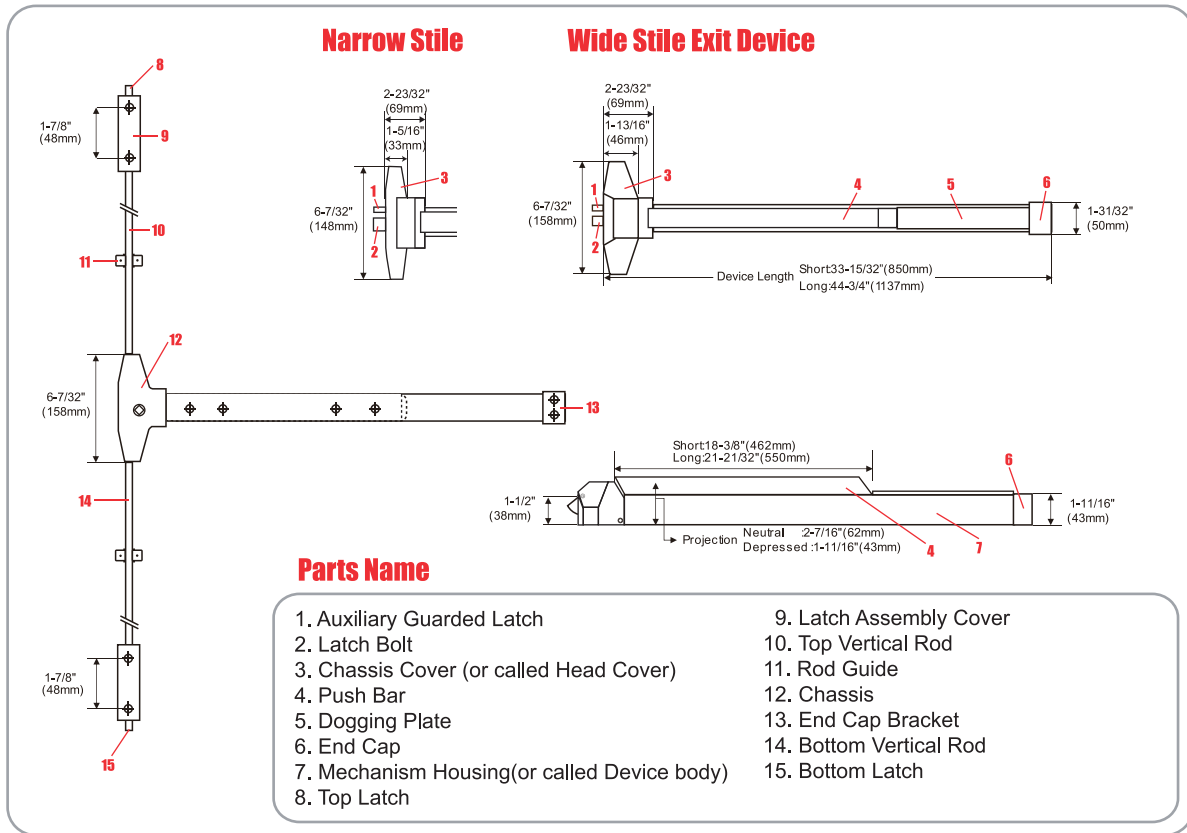

AUXILIARY HARDWARE-MULLION

Non-Fire Rated Keyed Removable Mullion, Model 7100



STRIKES

Rim Strike 801



Top Bracket 752



Top Bracket 755



SPECIFICATIONS

- ★ **Mullion Tube:** 2" (51mm) wide x 3" (76mm) deep, with wall thickness of 1/8" (3mm), 11 Gauge Steel Tube
- ★ **Mullion Size:** 7' (2134mm), 8' (2438mm) or 10' (3048mm) three sizes, mullion may be field cut to fit proper size
- ★ **Rim Cylinder:** Use a 1-1/4" solid brass 6-pin rim cylinder, model 426 or interchangeable core, model 308, sold separately
- ★ **Top Bracket:** Steel, using the key allows to removed the mullion in seconds. Mullion can be easily locked on the top bracket without using the key.
- ★ **Bottom Bracket:** Steel, fixed by 4 hex bolts with nonferrous anchors
- ★ **Shims:** 1/2" (13mm) and 5/8" (16mm) shims included
- ★ **Fasteners:** Each mullion includes:
 - 2 Flat Head Machine Screws, #5/16"-18 x 1-1/2" plated steel
 - 4 Flat Head Machine Screws, #5/16"-18 x 5/8" plated steel
 - 4 Hex Head Machine Screws, # 5/16"-18 x 1-1/4" , plated steel
 - 4 Extension Anchors, 5/8" dia. x 7/8" long, nonferrous alloy
- ★ **Strike:** Use two standard Rim Strikes (801), not included
- ★ **Finish:** Gray baked powder coating only

APPLICATION

- ★ BSI 7000 Series Keyed Removable Mullions are used with 5000 Series Rim Exit Devices on non-fire or fire rated pairs of doors. The 7100 Mullion is easy and fast removing from the top bracket by a simple operation of the rim cylinder when a clear, unobstructed large opening is required.

AUXILIARY HARDWARE-MULLION



Fire-Rated Keyed Removable Mullion, Model 7200

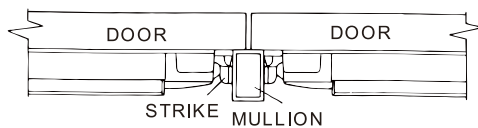

SPECIFICATIONS

- ★ **Mullion Tube:** 2" (51mm) wide x 3" (76mm) deep, with wall thickness of 1/8" (3mm), 11 Gauge Steel Tube
- ★ **Mullion Size:** 7' (2134mm), 8' (2438mm) two sizes, mullion may be field cut to fit proper size
- ★ **Rim Cylinder:** Use a 1-1/4" solid brass 6-pin rim cylinder, model 426 or interchangeable core, model 308, sold separately.
- ★ **Top Bracket:** Steel, using the key allows to removed the mullion in seconds. Mullion can be easily locked on the top bracket without using the key.
- ★ **Bottom Bracket:** Stainless Steel, fixed by 4 hex bolts with stainless steel anchors
- ★ **Shims:** 1/2" (13mm) and 5/8" (16mm) shims included
- ★ **Fasteners:** Each mullion includes:
 2 Flat Head Machine Screws, #5/16"-18 x 1-1/2" plated steel
 4 Flat Head Machine Screws, #5/16"-18 x 5/8" plated steel
 4 Hex Head Machine Screws, # 5/16"-18 x 1-1/4" , plated steel
 4 Extension Anchors, 5/8" dia. x 7/8" long, steel
- ★ **Strike:** Use two sets Mullion Strikes (688), & Strike Hooks (689), sold separately
- ★ **Finish:** Gray baked powder coating only

STRIKES

Mullion Strike 688



Mullion Strike 689



Top Bracket 752F



Top Bracket 755F



AUXILIARY HARDWARE-COORDINATOR



Surface Mounted Door Coordinator - SMC SERIES

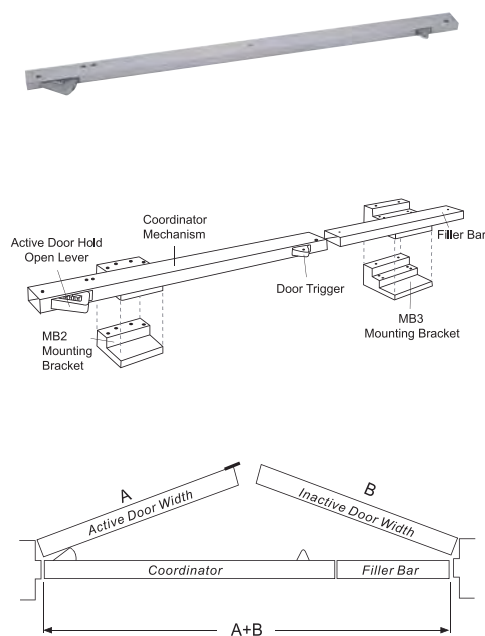

APPLICATION

- ★ A door coordinator adapted to control the closing of a pair of swinging doors constituted by an active door and an inactive door hung to swing into and out of closed position beneath a head frame.
- ★ As shown in drawing the Active Door Hold Open Lever is near to the active door open until the inactive Door Trigger is released to the retracted position by closing the inactives doors.

MODEL NUMBER & SIZE

Mode No.	Arm Size	Door Opening Widths
SMC-32	32"	34" - 43"
SMC-42	42"	44" - 53"
SMC-52	52"	54" - 96"
SMC-60	60"	97" - 112"

AUXILIARY HARDWARE-COORDINATOR



DORCO-2 & DORCO-3

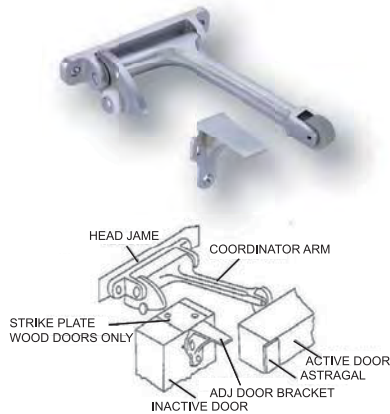

PROJECTION

- ★ Dorco - 2- 7"
 - Use on pairs of doors with astragal on active door up to 4'
 - With astragal in active up to 3' 4"
 - With astragal on both doors up to 2' 10"
- ★ Dorco - 3- 9"
 - Use on pairs of doors with astragal on active door over 4'
 - With astragal in active over 3' 4"
 - With astragal on both doors over 2' 10"

SPECIFICATIONS

- ★ All pairs doors Nos ____ shall have (Dorco-2, Dorco-3) Door coordinators which will prevent the active door from closing before the inactive door, by means of a gravity action arm and roller, adjustable on-site. Coordinator shall have a 7" projection (Dorco-3) and have a 7" projection (Dorco-3) and have all-brass construction.
 - ★ Door bracket adjustable for ease of installation. Rubber roller provides efficient quiet operation solid forged brass construction carry bar also available for use with coordinator to push active door open when inactive door open first helps prevent damage to astragal or other hardware.
 - ★ The coordinators are designed for use in pairs of doors with or without an astragal. Roller arm (Dorco-2-7" projection), (Dorco-3-9") prevents active door from closing before the inactive door.
 - ★ Gravity action arm and door bracket are adjustable on the job for ease of installation. Rubber roller provides quiet and efficient operation, and helps protect the astragal and doors from damage.
 - ★ Nylon roller or short arm glides smoothly over door bracket and strike, ensuring silent operation. The Dorco-2 and Dorco-3 are made of forged brass. When inactive door can be opened first, specify CBCO carry bar. Using door sizes and astragal locations select the device number from list at right.
- ★ Dorco - 2 & 3
SCREWS DETAILS:
- 2 · #8 x 3/4" truss head metal screws
 - 1 · #8 x 3/4" flat head sheet metal screws
 - 2 · #6 x 3/4" flat head sheet metal screws
 - 2 · #12 x 1" over head sheet metal screws

AUXILIARY HARDWARE-ANGEL TYPE



ANGEL TYPE



USE DESCRIPTION

- ★ This Door coordinator is also designed for use on pairs of doors when one door needs to close before the other. This device can set which leaf door to close first can close the other afterwards, to avoid both doors to hit each other when the door closer operate to close them.

MODEL NUMBER & SIZE

Mode No.	Arm Size	Finish
DC-250	250mm	US3, US4
DC-280	280mm	US32, US32D
DC-300	300mm	

AUXILIARY HARDWARE-ALARM



- ★ **Monitors push bar and latch bolt**
When the bar is depressed or the latch bolt. Its retracted by operating the outside lever trim, the alarm will sound.

SPECIFICATIONS

- ★ 5610 and 5810 Exit Devices can be converted into alarm devices. Its feature is used to deter and signal the unauthorized use if an opening. For warning someone to open a controlled door, the push bar is printed with "EMERGENCY EXIT ONLY, PUSH TO OPEN ALARM WILL SOUND" in red letter.
- ★ **Monitors push bar**
When the bar is depressed, the horn will sound. This type is suitable for exit device without outside lever trim(for exit only)

AUXILIARY HARDWARE-FLUSH BOLT



ANSI Accredited Program
PRODUCT CERTIFICATION

FB610M FB610W FB510M FB100



MANUAL FLUSH BOLTS

- ★ **Model No.:** FB510M-For Metal Doors
FB510W-For Wood Doors
- ★ Non-handed
- ★ **Label:** A (3-Hour Fire Exit Hardware).
- ★ **Face Plate:** FB610M - 1" x 6-3/4",
FB610W - 1" x 8-1/2"
- ★ **Finish:** US3, US4, US26, US26D, US32,
US32D
- ★ Use at top of door only, an automatic flush bolt combined use at bottom of door. Or a constant latching flush bolt combines with the auxiliary fire latch, providing significant reduction in door prep and eliminating floor prep entirely
- ★ When inactive door closes, flush bolt is automatically latched

AUTOMATIC FLUSH BOLTS

- ★ **Model No.:** FB610M (for metal doors), FB610W (for wood doors)
- ★ Non-handed.
- ★ **Label:** A (3-Hour Fire Exit Hardware).
- ★ **Face Plate:** FB610M - 1" x 6-3/4", FB610W - 1" x 8-1/2"
- ★ **Finish:** US3, US4, US26, US26D, US32, US32D
- ★ Use on inactive leaf of double wood / hollow metal doors.
Full automatic, when active door is opened, inactive door is free.
- ★ Automatically locks inactive door under high fire/heat conditions.
Used on the top and bottom of inactive door. If use one unit for top side only, it has to combined with auxiliary latch which replaces the bottom bolts

MANUAL FLUSH BOLTS

- ★ **Model No.:** FB100
- ★ Devices are ANSI A156.16
- ★ Length of Bolt Rod: 10-1/4" with 5/8" throw
- ★ Bolt diameter: 1/2"
- ★ Forged brass body, aluminum faceplate Non-handed.
- ★ Easy finger grip lever action and easy installation.
- ★ Tension spring action holds solidly in position.
- ★ Plunger supplied with milled surface on side which fits into a matching guild prevents bolt from turning and unscrewing
- ★ Lengths are from center of bolt
- ★ Mechanism when bolt head is retracted.
- ★ Finish: 605, 606, 625, 626
- ★ For dust-proof strike DP005, is available with a bottom manual flush bolt.

FIRE LATCH BOLT

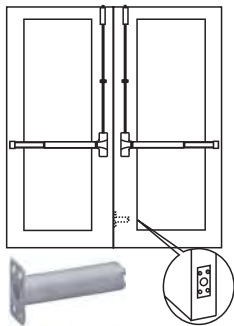

SPECIFICATIONS

- ★ A Fire latch bolt is used with a pair of UL listed fire rate LBR exit devices, it includes a spring loaded and a stainless steel bolt which installs in the lower door edge inside to replace bottom vertical rods of two SVR exit devices on a double door. The UL listed fire latch bolt is a temperature-actuated bolt that is designed to release from one door leaf and engage the other door when the temperature exceed the rating of the fusible link during a fire. When the fire latch bolt releases to connect the opposite door leaf, it keeps the doors in alignment and closed during the fire.

DOGGING OPTION



Less Dogging



Cylinder Dogging



SPECIFICATIONS

- ★ **Less Dogging(LD)**
Less Dogging is available on all 5000 Series Panic Exit Devices when users want to remove the dogging option.
- ★ **Cylinder Dogging(CD)**
Cylinder Dogging is available on all 5000 Series Panic Exit Device to replace the standard hex key dogging. Unit requires a standard 1-1/4" (32mm) mortise cylinder with a straight cam
- ★ **Cylinder Dogging Kit(CDK)**
For field conversion, a cylinder dogging conversion kit is available. It cannot be added to fire exit hardware.